

How to Improve the Selectivity of Zeolitic Catalysts in C₈ Aromatic Cut Isomerization

E. Guillon¹, S. Lacombe¹, T. Sozinho¹, P. Magnoux², S. Gnep², P. Moreau² and M. Guisnet²

¹ Institut français du pétrole, IFP-Lyon, Rond-point de l'échangeur de Solaize, BP 3, 69360 Solaize - France

² UMR 6503 CNRS - Université de Poitiers, Laboratoire de Catalyse en Chimie Organique, Faculté des Sciences, 40 avenue du Recteur Pineau, 86022 Poitiers Cedex - France

email: emmanuelle.guillon@ifp.fr - sylvie.lacombe@ifp.fr - tiago.sozinho@ifp.fr - patrick.magnoux@univ-poitiers.fr - ngi.suor.gnep@univ-poitiers.fr - pierre.moreau@oxfordcatalysts.com - michel.guisnet@univ-poitiers.fr

Résumé — Comment améliorer la sélectivité des catalyseurs zéolithiques en isomérisation de la coupe C₈ aromatique— Les catalyseurs utilisés dans les procédés d'isomérisation de la coupe C₈ aromatique (xylènes et éthylbenzène) sont généralement à base de platine supporté sur un support mixte liant/zéolithe. L'amélioration de ces catalyseurs consiste à augmenter la conversion de l'éthylbenzène, étape la plus difficile de cette transformation, en minimisant les réactions parasites secondaires telles que la dismutation et la désalkylation de l'éthylbenzène, l'ouverture de cycles naphthéniques et le craquage consécutif des paraffines résultantes. Parmi les différentes approches qui ont été menées, la majorité concerne l'optimisation de la phase zéolithique. Sur les catalyseurs conventionnels à base de zéolithe mordenite, le gain en sélectivité reste limité et il semble donc plus judicieux d'explorer de nouvelles structures zéolithiques. Dans ce cadre, des résultats intéressants ont été obtenus sur des catalyseurs à base de zéolithe EU-1, qui présente la particularité de se sélectiver lors de la mise en régime et de travailler en bouche de pore après stabilisation. Ce concept de catalyse en bouche de pore a pu être étendu à d'autres structures zéolithiques monodimensionnelles à taille de pore intermédiaire, telles que la ZSM-22 ou la ferrièreite. Par ailleurs, la sélectivité de la zéolithe EU-1 peut être optimisée en jouant sur la localisation des sites acides par utilisation de structurants organiques particuliers. Une autre approche a consisté à s'intéresser à l'ensemble du catalyseur (phases zéolithique et métallique, éventuellement associées à un support aluminique acide de type alumine chlorée), et à identifier les sites responsables des réactions de formation de paraffines. Les résultats montrent que le craquage des paraffines suit majoritairement un mécanisme bifonctionnel et, dans une moindre mesure, un mécanisme par hydrogénolyse, suggérant que la voie la plus prometteuse pour diminuer les pertes en paraffines est d'agir, en premier lieu, sur la zéolithe.

Abstract — How to Improve the Selectivity of Zeolitic Catalysts in C₈ Aromatic Cut Isomerization — The catalysts used in the isomerization processes of the C₈ aromatic cut (xylenes and ethylbenzene) generally contain platinum loaded on a mixed binder/zeolite support. Improving these catalysts consists in increasing the ethylbenzene conversion, which is the most difficult step in this transformation, while minimising the secondary side reactions such as ethylbenzene disproportionation or dealkylation, naphthene ring opening and consecutive cracking of the resulting paraffins. Most of the various adopted approaches concern optimisation of the zeolitic phase. The selectivity gain remains modest on conventional mordenite-based catalysts and it seems more appropriate to explore new zeolitic structures. In this context, interesting results have been obtained on EU-1-based catalysts, which selectivate during the stabilisation period and work then in pore mouth. It has been possible to extend this pore mouth catalysis concept to other one-dimensional zeolitic structures of intermediate pore size, such as ZSM-22 and ferrierite. In addition, the selectivity of EU-1 zeolite can be optimised by varying the acidic sites

location through the use of special organic templates. Another approach consisted in considering the entire catalyst (zeolitic and metallic phases, possibly associated with an acidic alumina support such as chlorinated alumina), and in identifying the sites responsible for the paraffin formation. The results demonstrate that paraffin cracking mainly follows a bifunctional mechanism, suggesting that the most promising way to reduce the paraffin yield is to act on the zeolite.

INTRODUCTION

Petrochemical applications, unlike fuel applications, require extremely pure products. Within the benzenic hydrocarbons family, this concerns benzene, xylenes (*meta*-xylene *m*-X, *ortho*-xylene *o*-X and *para*-xylene *p*-X), ethylbenzene (EB), isopropylbenzene (IPB) or cumene and paradiethylbenzene (PDEB). These products are derived mainly from reforming and steam cracking gasolines. These gasolines first undergo a series of treatments in an aromatic hydrocarbon processing plant (Fig. 1) to physically separate the B (benzene), T (toluene) and X (xylene) cuts [1]. The xylene cut (A8) is composed of a mixture of the three xylenes and ethylbenzene. It must undergo further conversions to adapt the production to market demand. One of the major conversions concerns the selective production of *para*-xylene, a much sought-after intermediate in the petrochemical industry since it is used in particular in the manufacture of polyester fibres and films from terephthalic acid (PTA) or dimethyl terephthalate (DMT); PTA and

DMT are converted by reaction with ethylene glycol into polyethylene terephthalate (PET) which is the base material for most polyester manufacturing processes. To a lesser extent, the *ortho*-xylene helps to make the phthalic anhydride used in the production of plastifiers for the polyvinyl chloride industry, alkyd resins and cross-linking agents for resins in particular.

The heart of the aromatic hydrocarbon processing plant is the aromatic loop, which consists of three units to allow production of the xylene isomers, in particular *para*-xylene, from the A8 cut [2]:

- a distillation column to separate the *ortho*-xylene and the aromatics containing at least nine carbon atoms from the rest of the aromatic cut;
- a *para*-xylene separation unit;
- a C₈ aromatic cut isomerization unit.

The EB content in the A8 cut depends on its origin. It is about 20% for reforming and 50% for steam cracking (Tab. 1).

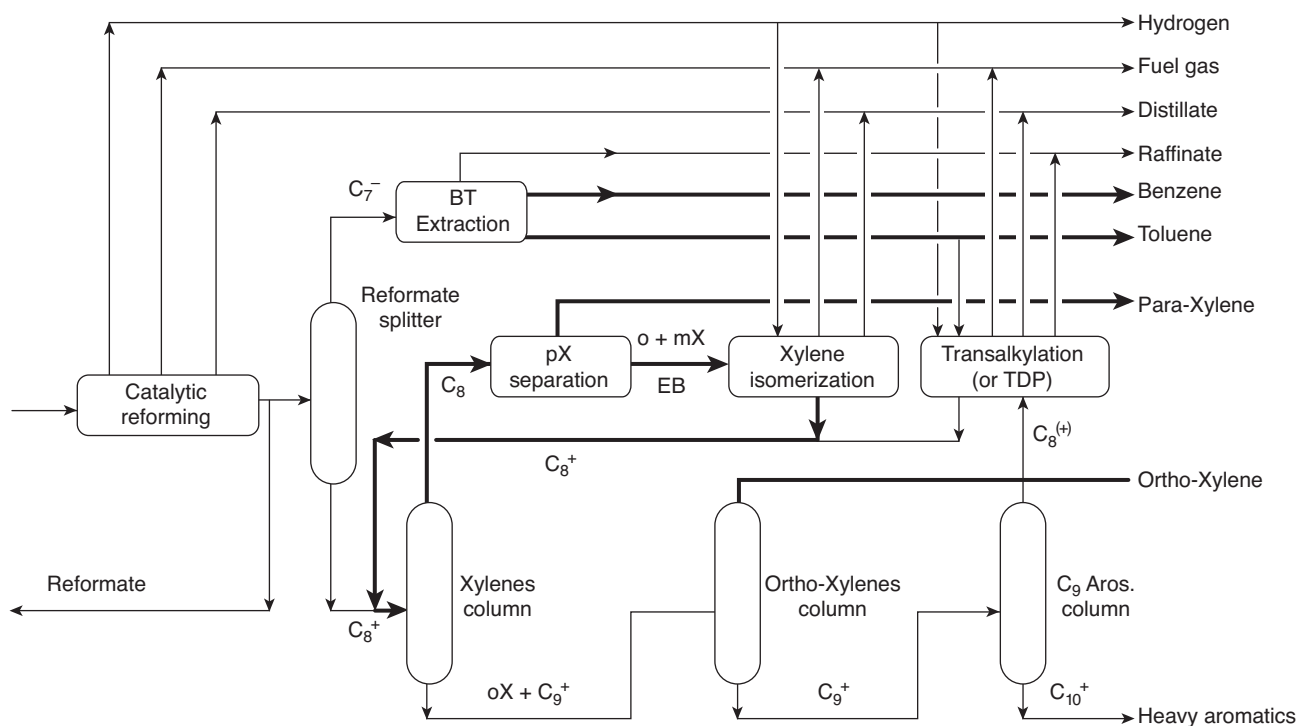

Figure 1

Diagram of an aromatic hydrocarbon processing plant. From [2].

TABLE 1

Typical composition of xylenes depending on the source process [2]

%	Steam cracking	Catalytic reforming	Thermodynamic (500°C)
EB	50	17	10
p-X	10	19	22
m-X	25	47	46
o-X	25	17	22
Total	100	100	100

Since the cost of separating ethylbenzene by distillation is too high, *para*-xylene and possibly *ortho*-xylene are recovered by selective separation on zeolite (according to various separation processes such as Eluxyl [3] (*IFP-Axens*) and Parex [4] (*UOP*) on molecular sieve). The residual C₈ cut is then processed in an isomerization unit, in order to produce as much *para*-xylene as possible and to convert ethylbenzene into xylenes or benzene. Depending on the benzene market, the petrochemical plants use an “isomerizing” or “dealkylating” isomerization unit, to privilege the production of either *para*-xylene alone or benzene and *para*-xylene.

Xylene isomerization occurs according to an acidic monofunctional mechanism, mono- or bimolecular depending on the porous characteristics of the acidic phase [2, 5-7]. Concerning ethylbenzene, the choice of catalyst depends on the target reaction. Ethylbenzene isomerization requires a bifunctional catalyst offering both an acidic function and a hydrogenating function. It has been demonstrated that ethylbenzene is first hydrogenated into ethylcyclohexene on the metallic sites then converted into dimethylcyclohexene on acidic sites by ring contraction then expansion, and lastly dehydrogenated into xylenes [8, 9]. When the target reaction is ethylbenzene dealkylation, it takes place on acidic sites only. However, the presence of a hydrogenating phase allows immediate hydrogenation of the ethylene formed, resulting in complete dealkylation. In both cases, incorporating a metallic phase in the catalyst also guarantees its stability. The industrial isomerization processes therefore use bifunctional heterogeneous catalysts loaded in fixed bed and operating in vapour phase under hydrogen pressure, with temperature ranges generally between 380°C to 440°C and pressures from 10 bar to 20 bar [2].

In the current industrial catalysts, acidity is generally provided by a zeolitic phase. Zeolitic catalysts have progressively replaced the former silica-alumina and halogenated alumina-based catalysts, since the shape selectivity offered by zeolites limits the secondary reactions. The catalysts generally contain platinum loaded on a mixed binder/zeolite support, in undisclosed proportions. Numerous industrial processes aimed at maximising xylenes production use a mordenite zeolite, whose MOR structural type corresponds to a one-dimensional porous structure with large pores (*Tab. 2*).

TABLE 2

Xylene isomerization processes using MOR type zeolite-based catalysts [10-12]. *nc* = not communicated

Process	Catalyst	Temperature (°C)	Pressure (bar)	H ₂ /HC (mol/mol)
Isolene (Toray)	Isolene	250-500	<i>nc</i>	4
Isomar (UOP)	I-9	388	<i>nc</i>	6-10
Octafining (Engelhard)	O-750	370-450	10-25 bar	4
Leuna	8830	430-450	<i>nc</i>	<i>nc</i>

These mordenite-based catalysts, however, undergo a number of secondary acidic reactions: disproportionation, dealkylation, transalkylation and cracking. Improving the catalyst performance would consist in increasing the ethylbenzene conversion, which is the most difficult step in this transformation, while minimising the secondary side reactions. New generations of catalysts, which are more *para*-xylene selective, have recently been announced by *IFP-Axens* [13, 14] and *UOP* [15]. They are based on the use of new zeolites.

Fundamentally, the most studied zeolites for ethylbenzene conversion are [12]:

- mordenite: one-dimensional, MOR structural type, 12-MR (6.7 × 7.0 Å), 8 MR side pockets (2.9 × 5.7 Å);
- ZSM-5: three-dimensional, MFI structural type, two types of interconnected 10 MR channels (5.3 × 5.6 Å and 5.1 × 5.5 Å).

Mordenite is the zeolite most frequently mentioned in the literature for xylenes and ethylbenzene isomerization, while ZSM-5 is preferred when performing ethylbenzene dealkylation. The impact of the porous structure on catalytic behaviour has been demonstrated experimentally in numerous publications [16-18]. In the 12 MR mordenite micropores the various reaction intermediates, including the bimolecular ones, suffer virtually no steric constraint. This was demonstrated, in particular, by molecular modelling of the *meta*-xylene disproportionation in mordenite zeolite, applying *ab initio* periodic calculations [19]. The most energetically favourable mechanism involves the formation of a benzylic carbocation, subsequently converted into a trimethyldiphenylmethane intermediate, this bimolecular step often being affected by steric constraints. It has been demonstrated that the adsorption energies of the various possible trimethyldiphenylmethane configurations were very similar in the MOR type zeolite, and therefore the steric constraints very low, which is not the case in the TON type zeolite (one-dimensional 10 MR). The formation of these bimolecular intermediates is also prevented in ZSM-5 and the ethylbenzene dealkylation considerably favoured [16].

According to Moreau *et al.* [20], the mordenite behaviour is highly dependent on the Si/Al molar ratio. At low Si/Al

molar ratio (less than or equal to 10), mordenite is subject to pore blocking by large hydrocarbon molecules, therefore a priori highly sensitive to deactivation by coke formation. These authors suggested that in this case only the external acidic sites of the zeolite crystallites participate in the isomerization reaction, the internal sites being rapidly blocked by coke. Dealumination to reach Si/Al molar ratios over 10 creates bridges between the channels, thereby improving the stability. In addition, partial exchange of protons by sodium ions [21, 22] improves the isomerization selectivity by reducing the secondary acidic reactions (disproportionation and dealkylation), but only to a limited extent.

Furthermore, Merlen *et al.* [23] consider that the performance in ethylbenzene isomerization is not solely due to the pore size (10 or 12 MR). After testing the mordenite, IM-5 and NU-85 zeolites, the authors suggested that the secondary reactions depend on the presence of large cavities within the zeolitic structures but also on the presence of strong acidic sites responsible for naphthene cracking reactions. An interesting, although difficult, approach would therefore consist in trying to selectively passivate these sites.

In conclusion, a number of avenues have been identified to improve the selectivity of mordenite-based catalysts, but the gain remains limited. Investigation of new zeolitic structures appears to be more beneficial.

1 SELECTIVATION OF EU-1 ZEOLITE-BASED CATALYSTS DURING THE STABILISATION PERIOD

Studies have recently been conducted on the C₈ aromatic cut isomerization on EU-1 zeolite. This EUO-structural-type zeolite discovered by ICI [24] belongs to the intermediate pore size zeolite family. The porous system consists in parallel, non-interpenetrating channels whose narrowest transverse cross-sections are surrounded by 10MR channels (5.8 × 4.1 Å) positioned in the crystallographic direction (100). They have deep 12 MR side pockets evenly spaced with a 6.8 × 5.8 Å cross-section (*Fig. 2*) [25, 26].

The PhD studies of Moreau [27], which concerned ethylbenzene isomerization on bifunctional Pt/Al₂O₃ - mordenite or EU-1 catalysts obtained by mechanical mixing, demonstrated better activity, selectivity and stability of EU-1-based catalysts compared with mordenite. Moreover, significant differences were observed in the modes of action of these catalysts:

- concerning the Pt/Al₂O₃ - EU-1 catalyst, the turnover frequency of the acidic sites in ethylbenzene disproportionation (main secondary reaction) is independent of the acidic site concentration, which is totally unexpected and the opposite to what was observed on mordenite. This demonstrates that parameters other than the number of protonic sites determine the disproportionation rate on EU-1;

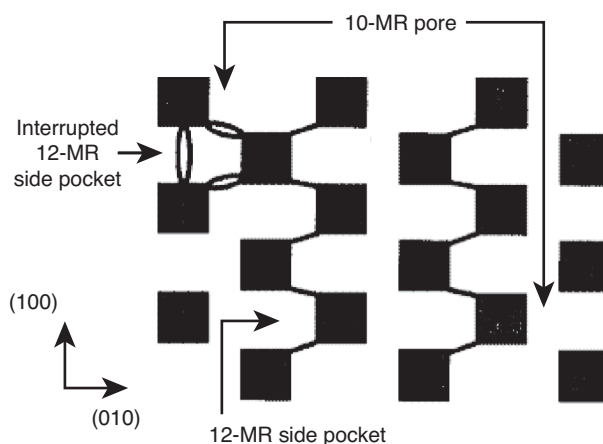

Figure 2

EUO structural type porous structure. From [25].

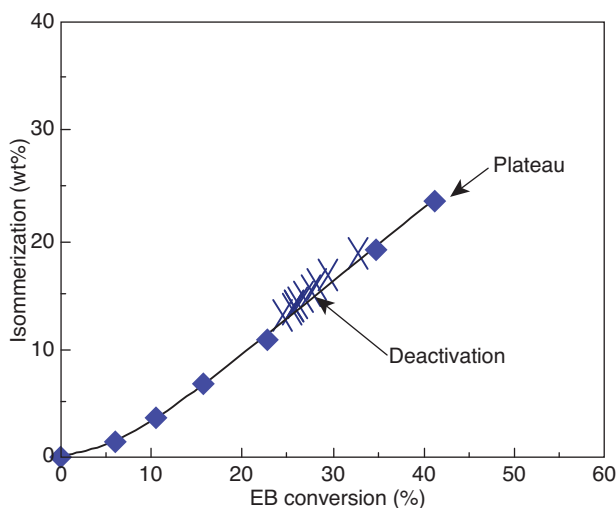

Figure 3

Yields in xylene isomers (wt%) during ethylbenzene conversion against total conversion, for the 2.3 wt% Pt/Al₂O₃ - MOR (75-25 wt%) catalyst, the mordenite having an Si/Al molar ratio of 10. Measurements during deactivation (x) and during stabilisation (plateau) (♦).

- for both catalysts, deactivation is observed initially followed by stabilisation. This results in significant selectivity with the Pt/Al₂O₃ - EU-1 catalyst, while no change in selectivity is observed with the Pt/Al₂O₃ - mordenite one. This behaviour is described in Figures 3 and 4 concerning respectively the 2.3 wt% Pt/Al₂O₃ - mordenite (Si/Al 10) and 2.3 wt% Pt/Al₂O₃ - EU-1 (Si/Al 15.2) catalysts. The aim is to compare the xylene yield at the same ethylbenzene conversion between the fresh catalysts and the stabilized ones. The xylene yield is clearly higher after catalyst stabilization for the catalyst containing EU-1 zeolite. In addition, the disproportionation and dealkylation yields drop, a phenomenon which is not observed with mordenite.

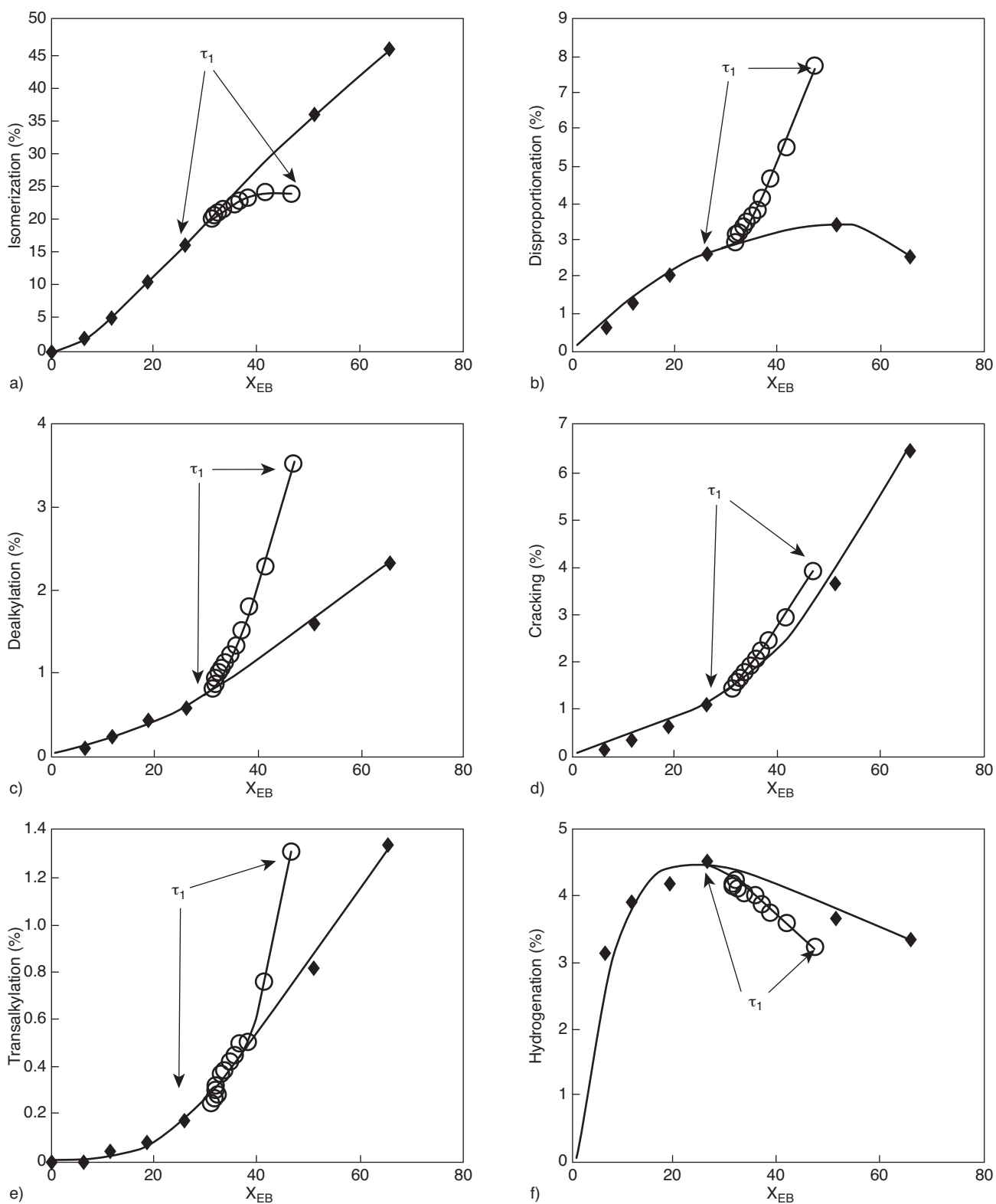

Figure 4

Comparison of yields (wt%) in isomerization a), disproportionation b), dealkylation c), cracking d), transalkylation e) and hydrogenation f) against ethylbenzene conversion, for the 2.3 wt% Pt/ Al_2O_3 - EU-1 (90-10 wt%) catalyst, the EU-1 zeolite having an Si/Al molar ratio of 15.2. (\blacklozenge) Measurements obtained on the stabilised catalyst (on the plateau). (\circ) Measurements obtained during the stabilisation period for a contact time τ_1 of 0.067 h. From [27].

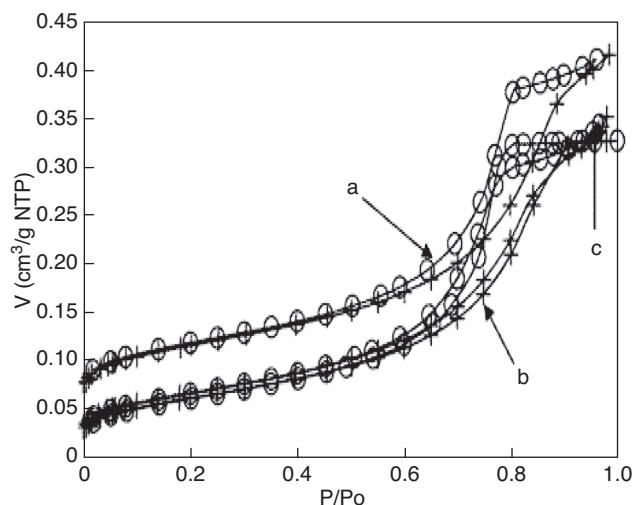

Figure 5

Nitrogen adsorption isotherm on fresh 4 wt% Pt/Al₂O₃ - EU-1 (55-45 wt%) a), 4 wt% Pt/Al₂O₃ reduced to 55 wt% b) and stabilised 4 wt% Pt/Al₂O₃ - EU-1 (55-45 wt%) c) catalysts. Volume (V) against the ratio between the nitrogen operating pressure and the saturation pressure. From [29].

Characterisation of both used catalysts have been carried out by nitrogen adsorption at 77 K. Coke deposit is observed in both cases. Only a part of the mordenite micropores is blocked: about 50% of the micropores remain accessible to the nitrogen for a 1.7 wt% coke deposit on a stabilised Pt/Al₂O₃ - mordenite (Si/Al 10) (75-25 wt%) catalyst. The nitrogen adsorption isotherm on a stabilised mechanical mixture of Pt/Al₂O₃ - EU-1 (Si/Al 15) (75-25 wt%) for 4 hours reaction and containing 1.4 wt% of coke shows that this coke deposit completely prevents the nitrogen from accessing the micropores. It is therefore suggested that the ethylbenzene conversion occurs at pore mouth in the case of the stabilised EU-1-based catalyst. Ethylbenzene may react on protonic sites or on hydrocarbon species trapped in the pores, as put forward by Guisnet for various reactions [28].

To characterise the phenomena associated with this behaviour, studies were conducted as part of Moreau's PhD work on catalysts containing a larger proportion of EU-1 zeolite and an alumina heavily loaded with platinum [29, 30]. The nitrogen adsorption isotherm on a stabilised mechanical mixture of 4 wt% Pt/Al₂O₃ - EU-1 (Si/Al 15) (55-45 wt%) after 30 hours reaction and containing 3.1 wt% of coke, is compared in Figure 5 with the fresh catalyst and with a 4 wt% Pt-Al₂O₃ catalyst (reduced to 0.55 wt%). The corresponding porosity data is included in Table 3.

The coked catalyst isotherm is very similar to that of the catalyst containing no zeolite (4 wt% Pt-Al₂O₃), which confirms complete blocking of the EU-1 microporosity. The initial deactivation of the EU-1-based catalyst may therefore be attributed to blocking of the internal acidic sites.

TABLE 3

Total porous, microporous and mesoporous volumes in cm³/g of fresh 4 wt% Pt/Al₂O₃ - EU-1 (55/45 wt%) (a), 4 wt% Pt/Al₂O₃ reduced to 55 wt% (b) and stabilised 4 wt% Pt/Al₂O₃ - EU-1 (55/45 wt%) (c) catalysts [30]

Catalyst	Porous volume (cm ³ /g)		
	Total	Micro	Meso
a	0.42	0.04	0.38
b	0.33	0.00	0.33
c	0.35	0.00	0.35

Coke extraction and analysis in the stabilised catalysts, according to a protocol developed during earlier studies [31, 32], demonstrated that initial deactivation of the EU-1-based catalyst is due to blocking of the zeolite micropores by a deposit of heavy aromatic compounds. The coke, extracted using either a Soxhlet extractor with dichloromethane or recovered after dissolution of the zeolite by a hydrofluoric acid solution, includes five families: alkylnaphthalenes, alkylfluorenes, ethyldiphenylethanes, alkylphenanthrenes and alkylpyrenes. The coke precursors are probably ethyldiphenylethanes, ethylbenzene disproportionation intermediates.

The acidity of the fresh 4 wt% Pt/Al₂O₃ - EU-1 (a) and coked (b) catalysts was determined by pyridine adsorption followed by infra-red spectroscopy. The data shown in Table 4 indicate that catalyst stabilisation results in a significant reduction in the concentration of Brønsted and Lewis acidic sites reacting with pyridine.

TABLE 4

Numbers of acidic sites capable of retaining pyridine at 150°C (μmol/g), during pyridine adsorption followed by infra-red spectroscopy on fresh and stabilised Pt/Al₂O₃ - EU-1 (55-45 wt%) catalysts

Catalyst	Brønsted (μmol/g)	Lewis (μmol/g)
(a) fresh 4 wt% Pt/Al ₂ O ₃ - EU-1	236	190
(b) stabilised 4 wt% Pt/Al ₂ O ₃ - EU-1	17	21

On stabilised catalyst, we may therefore consider that only sites on the zeolite outer surface are effective. A method has been developed to differentiate between the activities of the internal sites (in the zeolite micropores) and the external sites (zeolite outer surface), based on the activities and selectivities obtained after 45 and 450 minutes of reaction [29], as shown in Table 5. Up to about 450 minutes reaction, the ethylbenzene conversion drops and the isomerization selectivity increases; between 450 and 2400 minutes, the ethylbenzene conversion continues to drop but the selectivity to isomerization remains practically constant. This would suggest that the fresh catalyst has two

types of active site: external sites, relatively insensitive to deactivation and favourable to isomerization, and internal sites, highly sensitive to deactivation and favourable to disproportionation, dealkylation and cracking reactions. After stabilisation, these last three reactions become increasingly limited. The products distribution on the zeolite internal sites (non selective) is obtained by the difference in selectivities between 45 and 450 minutes. This indicates that, on the EU-1 internal sites, more than 66% of the products result from purely acidic reactions while less than 16% are obtained by isomerization.

TABLE 5

Ethylbenzene conversion and yields (selectivities) in isomerization, disproportionation, dealkylation, cracking and transalkylation for reaction times of 45, 450 and 2400 minutes for the 2 wt% Pt/Al₂O₃ - EU-1 (90-10 wt%) catalyst

Time-on-stream (minutes)	45	450	45-450	2400
Isomerization (%)	23.65 (59.1)	21.85 (75.75)	1.8 (16.2)	16.0 (78.5)
Disproportionation (%)	7.7 (19.25)	3.55 (12.3)	40.15 (37.2)	2.6 (12.7)
Dealkylation (%)	3.5 (8.75)	1.2 (4.15)	2.3 (20.6)	0.58 (2.85)
Cracking (%)	1.3 (3.25)	0.4 (1.4)	0.9 (8.1)	0.17 (0.85)
Transalkylation (%)	3.85 (9.65)	1.85 (6.4)	2.0 (17.9)	1.05 (5.1)
EB conversion (%)	43.2	32.75	10.45	24.9

In conclusion, EU-1 zeolite offers better selectivity compared with mordenite zeolite, due to its special porous structure which selectivates during the stabilisation period. The internal sites soon become inaccessible due to the formation of large hydrocarbon molecules inside the pores. After stabilisation, only the external sites participate in catalyst activity (pore mouth catalysis) and they are highly selective to isomerization.

2 CAN THE PORE MOUTH CONCEPT BE GENERALISED TO ZEOLITES OF INTERMEDIATE PORE SIZE?

The concept of pore mouth catalysis observed with EU-1 zeolite for the conversion of C₈ aromatics has already been discussed in the literature for various other reactions, for example hydroisomerization of *n*-alkanes on Pt/TON [33, 34] and skeletal isomerization of butenes on FER [35, 36]. The question therefore arose as to whether this concept could be extended to other zeolitic structures of intermediate pore size. The following zeolites were chosen [30, 37]:

- ZSM-5 (Si/Al 35 mol/mol): three-dimensional MFI structure – two types of interconnected 10MR channels (5.3 × 5.6 Å and 5.1 × 5.5 Å);

- ferrierite (Si/Al 10 mol/mol): FER structure – two types of interconnected channels with 10- (4.2 × 5.4 Å) and 8-MR (3.5 × 4.8 Å);
- ZSM-22 (Si/Al 33 mol/mol): one 10-MR channel (5.5 × 4.4 Å).

They were compared with mordenite zeolite (Si/Al 12 mol/mol) and EU-1 zeolite (Si/Al 15 mol/mol). The ethylbenzene isomerization selectivities on fresh catalyst and catalyst after 8 hours for an ethylbenzene conversion of about 35% are shown in Table 6.

TABLE 6

Selectivities observed during ethylbenzene conversion on 1 wt% Pt/Al₂O₃ - zeolite (90-10 wt%) catalysts, for fresh catalysts and catalysts after 8 hours reaction (figures between parentheses). Test conditions: 410°C, P = 10 bar, P(H₂)/P(EB) = 4. Ethylbenzene conversion around 35%. [37]

Zeolite	Isomerization	Disproportionation	Dealkylation	Cracking
ZSM-5 (MFI)	1(1)	3(3)	89(89)	7(7)
Ferrierite (FER)	66(75)	7(5)	19(14)	9(6)
ZSM-22(TON)	68(71)	4(4)	12(11)	16(14)
EU-1 (EUO)	54(72)	16(12)	15(6)	15(10)
Mordenite (MOR)	69(68)	23(25)	5(4)	3(3)

As previously observed with EU-1 zeolite, catalyst deactivation increases the isomerization selectivity and decreases the disproportionation and dealkylation selectivities, except for mordenite- and ZSM-5-based catalysts. The effect is especially pronounced in the case of ferrierite. Porosity measurements by nitrogen adsorption have been taken on fresh and stabilised catalysts (Tab. 7). To improve the accuracy when measuring the porous volumes, these characterisations were carried out on catalysts containing a larger proportion of zeolite (25 wt% instead of 10 wt%). These measurements show that the ZSM-22 microporosity is completely blocked by coke deposit like that of EU-1; the accessible ferrierite microporosity is significantly decreased (by a factor of 3 to 4); that of ZSM-5 zeolite is less affected (reduction by a factor of 1.5 to 2). Much of the ZSM-5 microporous volume probably remains accessible to ethylbenzene. With ferrierite, however, plugging by coke preventing access to ethylbenzene is highly likely. The microporous volume remains accessible to the nitrogen molecules via the 8-MR channels, but the latter are too narrow to allow ethylbenzene diffusion. It may therefore be assumed that the ZSM-22 and ferrierite-based catalysts behave in the same way as the EU-1-based catalyst: on the fresh catalyst, ethylbenzene is converted both in the internal micropores and on the outer surface, whereas it is converted on the outer surface only on the stabilised catalyst. As expected, the ZSM-5 based-catalyst is strongly dealkylating and the selectivities do not change over time under reaction mixture. The pore mouth concept is not

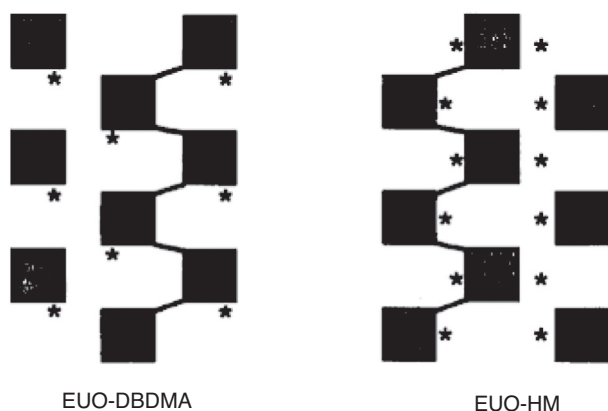

Figure 6

Location of EU-1 zeolite and ZSM-50 zeolite active sites. From [26].

applicable for this zeolite, which has a three-dimensional porous network with intersections that are difficult to block by coke.

TABLE 7

Microporous volume of fresh and stabilised 1 wt% Pt/Al₂O₃ - zeolite (75-25 wt%) catalysts and carbon content of the stabilised catalysts

Zeolite	C (wt%)	Microporous volume (cc/g)	
		Fresh	Stabilised
ZSM-5 (MFI)	3.2	0.03-0.04	0.02
Ferrierite (FER)	1.4	0.03-0.04	0.01
ZSM-22 (TON)	1.2	0.01-0.02	0.00
EU-1 (EUO)	1.3	0.03-0.04	0.00

The selectivity of acidic sites inside the microporosity was estimated by the difference between the selectivities obtained after 45 minutes reaction and those obtained after 8 hours reaction (Tab. 8).

The isomerization selectivity of the internal acidic sites is relatively low for zeolites of intermediate pore size and high for the mordenite zeolite. Only the very wide channels of mordenite zeolite therefore allow ethylbenzene isomerization into xylene.

In conclusion, the zeolites more selective to isomerization generally seem to be those with a one-dimensional porous network of large or medium size, provided that the active sites of the latter are located at pore mouth. A good compromise must be found between activity and selectivity, however. The activities of the stabilised catalysts mentioned previously vary considerably, ranging from 120 mmol/h/g of catalyst (with 10 wt% of zeolite) for MFI zeolite-based catalyst, to 43

TABLE 8

Selectivities (%) for isomerization, disproportionation, dealkylation and cracking of the internal acidic sites of the various zeolites for 1 wt% Pt/Al₂O₃ - zeolite (75-25 wt%) catalysts. Test conditions: 410°C, P = 10 bar, P(H₂)/P(EB) = 4. Ethylbenzene conversion around 35%

Zeolite	Isomerization	Disproportionation	Dealkylation	Cracking
ZSM-5 (MFI)	2	2	81	14
Ferrierite (FER)	18	6	48	28
ZSM-22 (TON)	40	6	23	31
EU-1 (EUO)	17	26	31	26
Mordenite (MOR)	68	25	4	3

for mordenite and 23 for EU-1 zeolite, and dropping to just 3.9 and 0.8 respectively for the ZSM-22 (TON) and ferrierite zeolites. Although highly selective to isomerization, the latter catalysts are not active enough to be chosen for isomerization of the C₈ aromatic cut.

3 INFLUENCE OF THE ACIDIC SITES LOCATION IN THE EUO ZEOLITE

EUO zeolites can be prepared from three different organic templates: hexamethonium (HM), dibenzyl-dimethylammonium (DBDMA) and hexamethyl-1,6-hexane diammonium. These three organic templates produce three zeolites, respectively: EU-1 [24], ZSM-50 [38] and TPZ-3 [39]. Figure 6 represents the porosity and acidic sites location of the two solids EU-1 and ZSM-50 [26]: the acidic sites are located only at the entrance of the side pockets in ZSM-50, while they are located in the channels and in the bottom of the side pockets in EU-1.

Moreau *et al.* [29, 30] studied the catalytic behaviour of EU-1 and ZSM-50 in ethylbenzene isomerization. The difficulty was that ZSM-50 zeolite synthesised with DBDMA could only be obtained with an Si/Al molar ratio of 62 (zeolite called EUO-62). It was therefore compared with two EU-1 zeolites of Si/Al molar ratio 15 and 70 (called respectively EUO-15 and EUO-70), the catalysts being prepared by mechanical mixing with a 1 wt% Pt/Al₂O₃ - zeolite (90-10 wt%) composition. The plots of ethylbenzene conversion against time (Fig. 7) show that the EUO-15-based catalyst deactivates more rapidly than the other two. Since the deactivation of the latter two catalysts is roughly the same, the concentration of acidic sites is therefore the determining factor, their positions playing at best only a secondary role. For all three catalysts, the initial deactivation induces a greater isomerization selectivity, which becomes constant after 450 minutes reaction. The participations of the internal and external sites as well as their selectivities have been estimated using the same method as mentioned

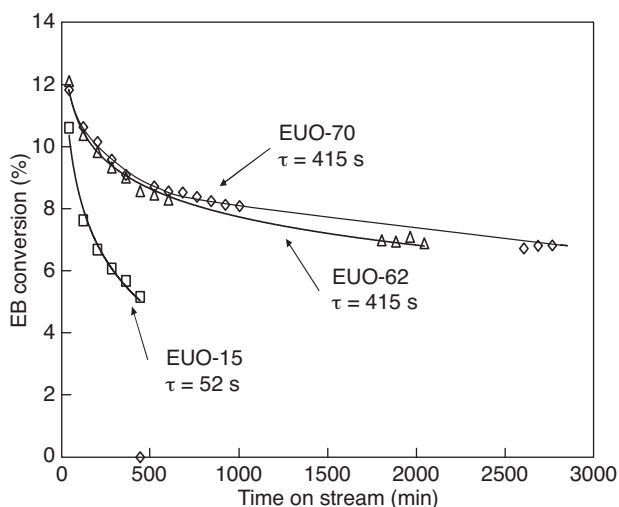

Figure 7

Ethylbenzene conversion (%) against time-on-stream for 1 wt% Pt/Al₂O₃ - zeolite (90-10 wt%) catalysts, in case of EUO-15 (HM template), EUO-62 (DBDMA template) and EUO-70 (HM template) zeolites. τ = contact time.

before. The results summarised in Table 9 show that the location of the protonic sites has a significant effect on the isomerization selectivity; it is higher on the catalyst synthesised from DBDMA (ZSM-50) for both the internal and the external sites. In addition, the disproportionation selectivity is clearly lower. The location of the protonic sites at the entrance of the side pockets (induced by DBDMA) would therefore be less favourable to disproportionation than location at bottom of the pockets (induced by HM).

TABLE 9

Comparison of selectivities of fresh EUO based-catalysts, for similar ethylbenzene conversion. Reactions in the internal micropores and on the outer surface

	X EB (%)		Isom. (%)	Disprop. (%)	Dealk. (%)	Crack. (%)	Transalk. (%)
EUO-15 (exHM, EU-1)	8	49% int. 51% ext.	26 65	30 23	23 6	19 5	2 0
EUO-70 (exHM, EU-1)	7	26% int. 74% ext.	21 37	36 20	26 38	13 4	3 2
EUO-62 (exDBDMA, ZSM-50)	8	27% int. 73% ext.	39 74	18 12	32 12	7 2	4 1

Unfortunately, ZSM-50 zeolite is difficult to synthesise at low Si/Al ratio, which induces low global activity. In addition, the crystallites of these two zeolites have different sizes: larger for ZSM-50 (polyhedral crystals of side 1 to 3 μ m)

than for EU-1 zeolite of Si/Al molar ratio 15 (micrograins of average diameter about 50 nm agglomerated into "rice grains" 1 μ m long). The quantity of pore mouths accessible per gram of solid is therefore much less with ZSM-50 zeolite than with EUO-15 zeolite. To capitalise on the high selectivity of ZSM-50, a new synthesis method producing a lower Si/Al ratio and smaller crystallites should therefore be developed.

4 IDENTIFICATION OF THE SITES RESPONSIBLE FOR CRACKING REACTIONS

All the side reactions (disproportionation, dealkylation, hydrogenation, naphthene ring opening, cracking into paraffins containing 1 to 7 carbon atoms) affect the *para*-xylene yield of the aromatic loop. Losses through hydrogenation and disproportionation can be avoided by careful recycling of the naphthenes and aromatics formed, although this increases the plant's investment cost. The same approach cannot be adopted to reduce the products formed by cracking (light paraffins C₁-C₇ and octanes) which represent a net *para*-xylene loss. It is therefore important to understand which parameters govern ring opening and subsequent cracking.

Although it is widely accepted that the cracking step leading to C₃-C₅ paraffins is bifunctional, the active sites involved in the first naphthene ring opening step still remain uncertain. The catalyst is complex, combining a zeolitic phase and a hydrogenating phase generally deposited on a more or less acidic alumina support. Part of the acidity is governed by the chlorine content, which depends on the metal deposition mode, in particular the type and concentration of the competitor used to optimise the distribution of the metal within the shaped catalysts. In addition, the quantity of active zeolitic acidic sites is not necessarily large, *a fortiori* in the case of EU-1 zeolite whose micropores are rapidly plugged by heavy hydrocarbon molecules. The contribution of each component in the catalyst must therefore be determined. It has been reported in the literature that under the C₈ aromatic isomerization operating conditions, therefore in the presence of the corresponding naphthenes and cycloalkenes, ring opening may occur through three mechanisms involving either one or both of the two phases of the bifunctional catalyst:

- metallic sites [40], the reaction (hydrogenolysis) resulting in a statistical products distribution;
- acidic sites (on chlorinated alumina [41]), ring opening being governed by the carbocation formation kinetics;
- acidic and metallic sites [42, 43], the bifunctional reaction generally being governed by the carbocation β -scission step.

It was therefore decided to study the three catalytic functions present in the catalyst first separately then in combination [44], evaluating the performance of model catalysts in ethylcyclohexane conversion. The following conditions

were applied: 390°C, 13 bar abs, H₂/HC of 4 mol/mol, ethylcyclohexane flow rate between 0.2 g and 8 g per gram of catalyst and per hour (giving a contact time between 22 s and 900 s).

Scheme 1 is a simplified representation of the various pathways possible for the ethylcyclohexane conversion on a bifunctional catalyst, which are:

- ethylcyclohexane isomerization by ring contraction – expansion via partially dehydrogenated intermediates then carbocations;
- total naphthene dehydrogenation to form aromatics on metallic sites;
- naphthene opening into paraffins on sites which should be identified;
- paraffin isomerization via carbocationic intermediates;
- cracking of the paraffins formed during ring opening into shorter paraffins by β -scission on the acidic sites or hydrogenolysis on the metallic sites;
- naphthene and aromatic dealkylation by acidic or metallic catalysis to produce methane and ethane.

In the expression of the catalysis results, the naphthene yields exclude the unconverted ethylcyclohexane. In other words, the sum of the yields is equal to the ethylcyclohexane conversion.

To identify the sites responsible for ring opening, the following model catalysts were tested:

- two purely acidic catalysts: Al₂O₃ - 1.6 wt% Cl, obtained by acidification of a γ -alumina by hydrochloric acid, and Al₂O₃ - EU-1 (90-10 wt%) obtained by extrusion;
- a purely metallic catalyst: 0.3 wt% Pt/Al₂O₃, the platinum being deposited by dry impregnation on a γ -alumina (200 m²/g) using platinum diacetylacetonate as precursor;

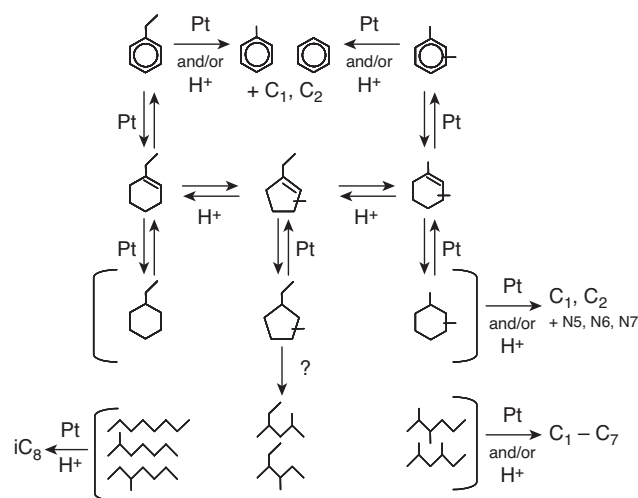

Scheme 1

Simplified diagram of the main ethylcyclohexane conversion pathways on bifunctional catalyst containing metallic (Pt) and acidic (H⁺) sites.

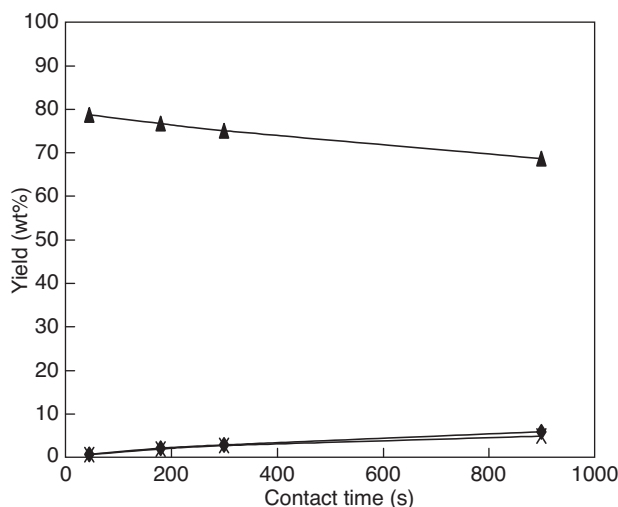

Figure 8

Yields in C₁ to C₈ paraffins (◆), naphthenes (×) and aromatics (▲) (wt%) against contact time, obtained on 0.3 wt% Pt/Al₂O₃ catalyst; feed: ethylcyclohexane; test conditions: 390°C, 13 bar abs, H₂/HC 4 mol/mol, ethylcyclohexane flow rate between 0.2 and 4 g per gram of catalyst and per hour.

- a catalyst containing a metallic phase associated with a weakly acidic function: 0.3 wt% Pt/Al₂O₃ - 1.3 wt% Cl, the platinum being deposited by impregnation in excess on the γ -alumina, using hexachloroplatinic acid as precursor and hydrochloric acid as adsorption competitor;
- a catalyst combining the three functions (Pt, Al₂O₃-Cl and EU-1): (0.3 wt% Pt/Al₂O₃ - 1.3 wt% Cl) - EU-1 (90-10 wt%), the platinum being deposited by impregnation in excess on the shaped Al₂O₃-EU-1 support, using hexachloroplatinic acid as precursor and hydrochloric acid as adsorption competitor.

For the last three catalysts, the platinum dispersion measured by H₂-O₂ titration is high, respectively equal to 76%, 82% and 90%. Before the test, the catalysts were calcined under air at 520°C and atmospheric pressure, then reduced under hydrogen at 13 bar abs and 450°C.

On chlorinated alumina with no metal, the ethylcyclohexane conversion is very low (< 5%). To check that this conversion does not result from a thermal process, the product distribution was compared with that obtained without any catalyst for the same conversion value (2%). The selectivity to paraffins and olefins is equal to 30% by thermal pathway and 70% on chlorinated alumina. This shows that ring opening on chlorinated alumina is possible under the C₈ aromatic cut isomerization conditions, in agreement with Brandenberger *et al.* [41].

Table 10 allows to compare the behaviour of the four other catalysts. On the purely metallic Pt/Al₂O₃ catalyst, the

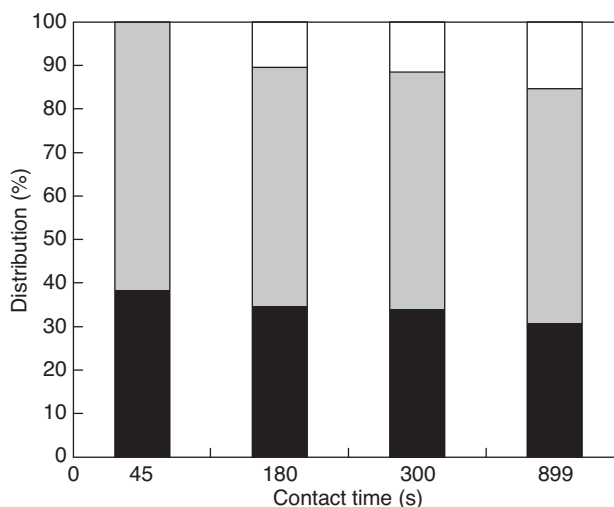

Figure 9

Distribution within C₈ paraffins (%), obtained on 0.3 wt% Pt/Al₂O₃ catalyst; feed: ethylcyclohexane; test conditions: 390°C, 13 bar abs, H₂/HC 4 mol/mol, ethylcyclohexane flow rate between 0.2 and 4 g per gram of catalyst and per hour. Linear (black), monobranched (grey) and multibranched (white) paraffins.

ethylcyclohexane conversion remains virtually constant around 80 % irrespective of the contact time (Fig. 8), which can be explained by a rapid dehydrogenation equilibrium. Since the other catalysts do not exhibit the same behaviour, their activities can be compared. The bifunctional catalysts are more active than the purely acidic Al₂O₃-EU-1 catalyst. The more active of the two bifunctional catalysts is Pt/Al₂O₃-Cl-EU-1, which includes the three catalytic components: platinum, chlorinated alumina and zeolite. The difference in activity is very pronounced: 91% conversion is obtained for a contact time 40 times lower than on the catalyst Pt/Al₂O₃-Cl, which is therefore about 40 times less active.

The catalyst selectivities are also quite different. On the purely metallic Pt/Al₂O₃ catalyst, ethylbenzene is the major compound (~90 wt% of the products). The other products are naphthenes, a very large majority of methylethylcyclopentane resulting from isomerization of ethylcyclohexane, and paraffins (Fig. 8). The paraffin yield does not exceed 6 wt%, including at most 3 wt% paraffins with eight carbon atoms (P8) which are direct ring opening products. Amongst these P8, the distribution in linear, mono- and multibranched molecules (Fig. 9) is consistent at low contact time with the statistical distribution described by Gault [40] for ring opening on purely metallic catalysts (1/3 nC₈ and 2/3 i-C₈). At longer contact time the distribution is more complex, due either to paraffins isomerization or ring opening of the naphthenic isomers. The cracking products (C₁ to C₇) are largely methane and ethane, from ring paring reactions or paraffin hydrogenolysis reactions (Fig. 9).

TABLE 10

Ethylcyclohexane conversion, corresponding contact times, yields by product family and distribution within the C₈ paraffins, obtained for catalysts 0.3 wt% Pt/Al₂O₃, 0.3 wt% Pt/Al₂O₃ - 1.3 wt% Cl, Al₂O₃ - EU-1 (90-10 wt%) and (0.3 wt% Pt/Al₂O₃ - 1.3 wt% Cl) - EU-1 (90-10 wt%); feed: ethylcyclohexane; test conditions: 390°C, 13 bar abs, H₂/HC 4 mol/mol

	Pt/Al ₂ O ₃	Al ₂ O ₃ -EU-1	Pt/Al ₂ O ₃ - Cl	(Pt/Al ₂ O ₃ - Cl)-EU-1
EtCC6 conversion (%)	81	36	81	91
Contact time (s)	180	180	180	900
Yield in naphthenes (wt%)	1.9	10.7	11.3	12.6
Yield in aromatics (wt%)	76.7	3.5	64.7	59.0
Yield in paraffins + olefins (wt%)	2.1	20.2	6.6	17.9
Yield in C ₈ paraffins (wt%)	0.6	2.7	4.15	12.3
Yield in C ₁ -C ₇ paraffins (wt%)	1.4	16.5	2.3	5.2
Distribution within C ₈ paraffins (%):				
nC ₈	34	31	29	24
monoB C ₈	57	14	48	41
muB C ₈	9	55	23	35

On the purely acidic Al₂O₃-EU-1 catalyst, deactivation is observed from the start of the test and the catalyst then stabilises, provided that the contact time does not exceed 180 s. Consequently, only the points obtained at contact times between 45 s and 180 s will be considered. They correspond to an ethylcyclohexane conversion of maximum 38%. The three product families (paraffins/olefins, naphthenes and aromatics) are formed (Fig. 10). The C₈ naphthenes are obtained by direct acidic ethylcyclohexane isomerization. The aromatic compounds result from hydrogen transfer reactions, *i.e.* reactions between a substituted (or not) cyclohexane molecule and three olefins, the latter resulting from the cracking of ethylcyclohexane and its isomers by acidic catalysis. Hydrogen transfer reactions convert a large fraction of the olefins into paraffins; the olefin/paraffin weight ratio in the liquid phase lies between 0.21 and 0.26 although naphthenes cracking produces only olefins. The P8 yield is low: 2.7 wt% for a contact time of 180 s. The distribution within these paraffins varies very little with contact time: about 55% multibranched, 13% monobranched and 32% *n*-octane. *n*-Octane and the monobranched isomers may result from C₈ naphthenes cracking, the olefins formed being saturated by hydrogen transfer reactions. Isomerization of these linear and monobranched olefins into multibranched olefins, followed by their saturation by hydrogen transfer reactions, could explain the formation of the multibranched P8. These products could also result from the cracking of highly branched naphthenes (*e.g.* trimethylcyclopentanes) followed by saturation by hydrogen transfer reactions of

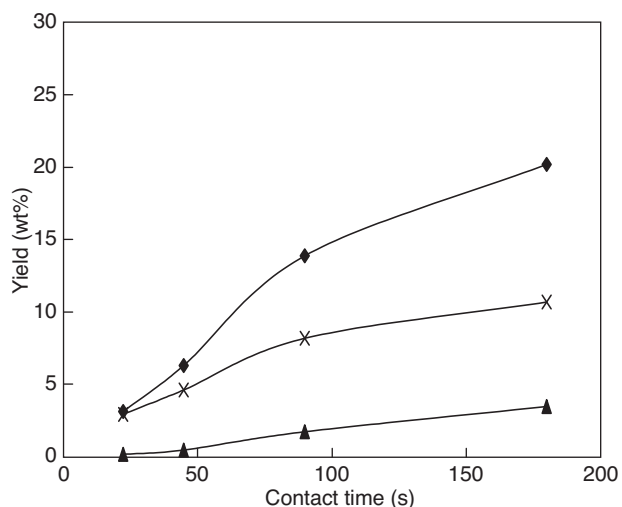

Figure 10

Yields in C₁ to C₈ paraffins and olefins (♦), naphthenes (×) and aromatics (▲) (wt%) against contact time, obtained on Al₂O₃ - EU-1 (90-10 wt%) catalyst; feed: ethylcyclohexane; test conditions: 390°C, 13 bar abs, H₂/HC 4 mol/mol, ethylcyclohexane flow rate between 0.2 and 4 g per gram of catalyst and per hour.

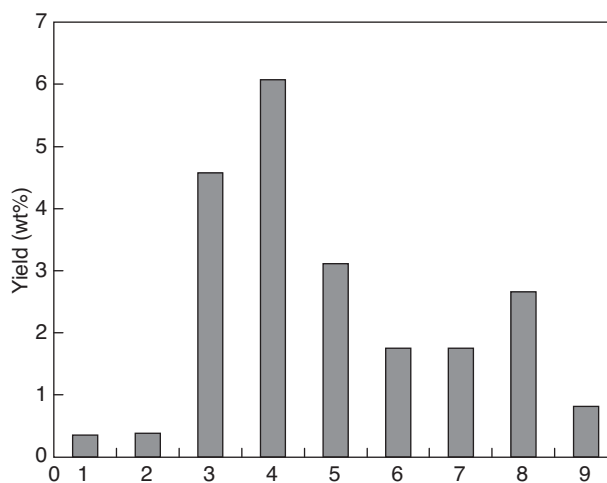

Figure 11

Yields in paraffins by number of carbon atoms (in wt%) for a contact time of 180 s, obtained on Al₂O₃ - EU-1 (90-10 wt%) catalyst; feed: ethylcyclohexane; test conditions: 390°C, 13 bar abs, H₂/HC 4 mol/mol. Ethylcyclohexane conversion around 40%.

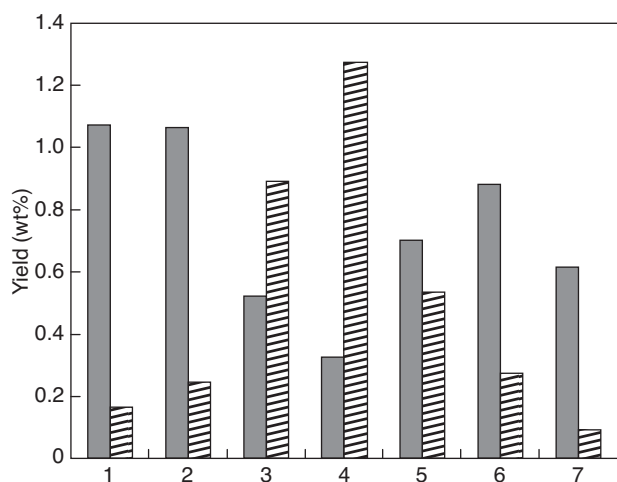

Figure 12

Yields in C₁ to C₇ paraffins (wt%) by number of carbon atoms, obtained for the 0.3 wt% Pt/Al₂O₃ - 1.3 wt% Cl (grey) and (0.3 wt% Pt/Al₂O₃ - 1.3 wt% Cl) - EU-1 (90-10 wt%) (hatched) catalysts; feed: ethylcyclohexane; test conditions: 390°C, 13 bar abs, H₂/HC 4 mol/mol. Ethylcyclohexane conversion around 90%.

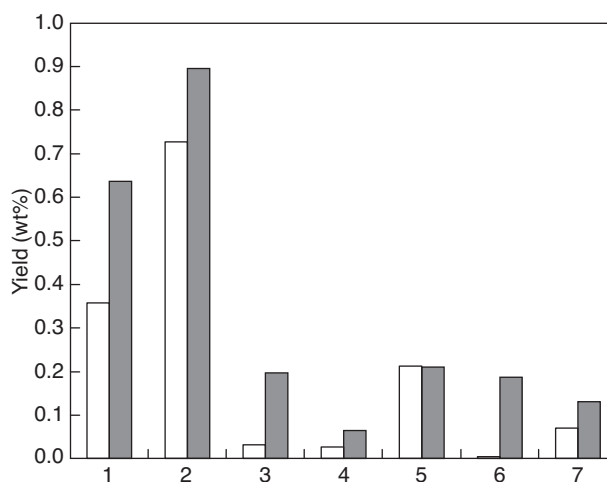

Figure 13

Yields in C₁ to C₇ paraffins (wt%) by number of carbon atoms, obtained for a contact time of 180 s, for the 0.3 wt% Pt/Al₂O₃ (white) and 0.3 wt% Pt/Al₂O₃ - 1.3 wt% Cl (grey) catalysts; feed: ethylcyclohexane; test conditions: 390°C, 13 bar abs, H₂/HC 4 mol/mol. Ethylcyclohexane conversion around 80%.

the olefins formed. The cracking products are shown in Figure 11. The main products have three and four carbon atoms, as expected from β -scission reactions. The low C₁ and C₂ yields could be explained by cracking by protolysis (formation of a carbenium then simultaneous rupture of a

C-H bond and a C-C bond). In conclusion, the purely zeolitic catalyst promotes numerous primary and secondary reactions, in particular naphthene ring opening, cracking of the olefins formed and saturation of C₃-C₈ olefins by hydrogen transfer reactions.

Selectivities of the bifunctional Pt/Al₂O₃-Cl and Pt/Al₂O₃-Cl-EU-1 catalysts are quite different from that of the purely metallic (Pt/Al₂O₃) or acidic (Al₂O₃-EU-1) monofunctional catalysts (Tab. 10). Adding an acidic function to the metallic catalyst decreases the selectivity to aromatics while increasing that to naphthenes and paraffins, therefore favouring ring opening. In addition, adding a metallic function to the acidic catalyst significantly increases the production of aromatics at the expense of paraffin formation; the olefin content also becomes negligible. However, the global paraffins yield as well as the P8 yield are lower on the zeolitic bifunctional catalyst than on the Pt/Al₂O₃-Cl catalyst. Furthermore the C₁-C₇ cracking products obtained on the zeolitic catalyst are rich in paraffins with 3, 4 and 5 carbon atoms (Fig. 12), according to a distribution typical of a bifunctional mechanism. Methane and ethane are also present, but in smaller quantities, whereas the cracking products on Pt/Al₂O₃-Cl catalyst are rich in methane and ethane. On the latter catalyst, the hydrogenolysis reactions on metallic sites therefore remain predominant and the distribution is closer to that observed on Pt/Al₂O₃ catalyst (Fig. 13).

Two hypotheses can thus be considered for the Pt/Al₂O₃-Cl catalyst:

- ring opening reaction occurs according to a bifunctional mechanism but the consecutive cracking reactions remain on the metallic site (unlikely);
- chlorinated alumina allows ECH isomerization, and the resulting naphthenes are more easily opened then cracked on the metallic phase.

Concerning the zeolitic catalyst, two hypotheses can also be considered:

- chlorinated alumina is mainly involved in the ring opening, through a bifunctional mechanism, and the further cracking reactions involve the zeolite (unlikely);
- the chlorinated alumina activity is inhibited by the presence of the stronger acidic zeolitic sites, which are responsible for the naphthenic ring opening; the lower paraffin yield would then be explained by a good equilibrium between zeolitic acidic sites and metallic sites favouring naphthene isomerization.

The last explanation suggest that the most promising way to reduce the paraffin losses is to act on the zeolite (change the acidity or the acidic sites location). A modification of the metallic phase is expected to have less impact.

CONCLUSION

Various approaches have been adopted to improve the selectivity of the C₈ aromatic cut isomerization catalysts. Most concern optimisation of the zeolitic phase. On conventional mordenite-based catalysts, changing the density of the zeolite acidic sites, for example by partially exchanging the protonic sites by sodium ions, produces interesting results. Unfortunately, the porous network of this zeolite favours disproportionation since the bimolecular reaction intermediates

experience no steric constraints and, as a result, the selectivity gain remains limited. It therefore seemed more appropriate to explore new zeolitic structures. In this context, interesting results have been obtained on EU-1-based catalysts (EUO structural type). Selectivation during the stabilisation period under reaction stream is observed, related to plugging of the microporosity by large organic molecules. As a consequence only the outer surface sites remain active on the stabilised catalyst (pore mouth catalysis) and these sites are highly selective to isomerization. It has been possible to extend this pore mouth catalysis concept to other one-dimensional zeolitic structures of intermediate pore size, such as ZSM-22 and ferrierite. However, to make the essential compromise between selectivity and activity, zeolites more selective than EU-1 are ruled out, being much less active since they do not have sufficient external acidic sites. The selectivity of EUO zeolites can be improved by changing the acidic sites location through the use of special organic templates. Once again, the difficulty is how at the same time to maintain a good level of activity, governed by low Si/Al ratios and small crystallite sizes.

Another approach aimed at improving the process selectivity consists in considering the catalyst as a whole, composed of a zeolitic phase, a metallic phase and possibly an acidic alumina support (chlorinated alumina). The side reactions causing a net aromatics loss are the paraffin formation reactions, which may occur through various mechanisms: metallic, acidic or bifunctional. The results obtained demonstrate that the reactions of cracking, ring opening and secondary cleavage of the products formed are easier by bifunctional catalysis than by hydrogenolysis. Consequently, the most promising way to reduce the paraffin yield seems to act on the zeolite. The modification of the metallic phase is expected to have less impact.

REFERENCES

- 1 Alario F., Barraqué M., Marcilly C. (1997) Traitement des essences aromatiques pour la pétrochimie, *Techniques de l'Ingénieur*, J5920-1-J5920-12.
- 2 Alario F., Guisnet M. (2002) Paraxylene manufacturing: catalytic reactions and processes, *Catalytic Sci. Series* **3**, 189-207.
- 3 Ash G., Barth K., Hotier G., Mank L., Renard P. (1994) Eluxyl - A New Paraxylene Separation Process, *Revue de l'Institut Français du Pétrole* **49**, 5, 541-549.
- 4 Kurup A.S., Hidajat K., Ray A.K. (2005) Optimal operation of an industrial-scale Parex process for the recovery of p-xylene from a mixture of C-8 aromatics, *Ind. Eng. Chem. Res.* **44**, 15, 5703-5714.
- 5 Corma A., Sastre E. (1991) Evidence for the presence of a bimolecular pathway in the isomerization of xylene on some large-pore zeolites, *J. Catal.* **129**, 177-185.
- 6 Guisnet M. (1998) Procédés sélectifs et propres de production d'alkylaromatiques sur zéolithes, *Actual. Chimique* 9-15.
- 7 Morin S., Gnep N.S., Guisnet M. (1996) A simple method for determining the relative significance of the unimolecular and bimolecular pathways of xylene isomerization over HY zeolites, *J. Catal.* **159**, 296-304.

- 8 Gnep N.S., Guisnet M. (1977) Isomérisation de l'éthylbenzène sur platine supporté par alumine fluorée : I. Influence des fonctions acide et métallique sur l'activité et la sélectivité, *B. Soc. Chimique France* **5-6**, 429-434.
- 9 Weisz P.B. (1962) Polyfunctional heterogeneous catalysis, *Adv. Catal.* **13**, 137-190.
- 10 Ransley D.L. (1990) Xylenes and ethylbenzene, *Encyclopedia Chem. Technol.* **24**, 709-744.
- 11 John H.H., Neubauer H.D., Birke P. (1999) Zeolite containing catalysts for the conversion of C₈-aromatics, *Catal. Today* **49**, 211-220.
- 12 Marcilly C. (2006) Conversion of simple aromatic feedstocks, in *Acido-basic Catalysis*, Editions Technip, Paris.
- 13 Dupraz C., Alario F., Renard C. (1999) *DGMK Conference*, Erlangen Oct. 13-15.
- 14 Rault J., Dupraz C., Montécot F. (2004) Alternative routes to paraxylene production, *PTQ*, Spring.
- 15 Palmer P., Marr G. (2005) Innovation delivered: new catalysts and adsorbents for increased p-xylene production, *Proceedings of International Petrochemical Technology Conference*.
- 16 Martens J.A., Perez-Pariente J., Sastre E., Corma A., Jacobs P.A. (1988) Isomerization and disproportionation of m-xylene; selectivities induced by the void structure of the zeolitic framework, *Appl. Catal.* **45**, 85-101.
- 17 Silva J.M., Ribeiro M.F., Ribeiro F.R., Benazzi E., Guisnet M. (1995) Transformation of An Ethylbenzene-O-Xylene Mixture on HMOR and Pt-HMOR Catalysts - Comparison with ZSM-5 Catalysts, *Appl. Catal. A-Gen.* **125**, 1, 15-27.
- 18 Jones C.W., Zones S.I., Davis M.E. (1999) m-xylene reactions over zeolites with undimensional pore system, *Appl. Catal. A-Gen.* **181**, 289-303.
- 19 Demuth T., Raybaud P., Lacombe S., Toulhoat H. (2004) Effects of zeolite pore sizes on the mechanism and selectivity of xylene disproportionation - a DFT study, *J. Catal.* **222**, 2, 323-337.
- 20 Moreau F., Bernard S., Gnep N.S., Lacombe S., Merlen E., Guisnet M. (2001) Ethylbenzene isomerization on bifunctional platinum alumina-mordenite catalysts 1. Influence of the mordenite Si/Al ratio, *J. Catal.* **202**, 2, 402-412.
- 21 Moreau F., Gnep N.S., Lacombe S., Merlen E., Guisnet M. (2002) Ethylbenzene transformation on bifunctional Pt/Al₂O₃-NaHMOR catalysts Influence of Na exchange on their activity and selectivity in ethylbenzene isomerization, *Appl. Catal. A-Gen.* **230**, 1-2, 253-262.
- 22 Moreau F., Ayrault P., Gnep N.S., Lacombe S., Merlen E., Guisnet M. (2002) Influence of Na exchange on the acidic and catalytic properties of an HMOR zeolite, *Micropor. Mesopor. Mat.* **51**, 3, 211-221.
- 23 Merlen E., Lacombe S., Alario F. (2000) A study of catalytic performances in isomerization of the C₈ aromatic cut for different zeolite structures, *Proceedings of the Industrial Applications of Zeolites*, Brugge, Belgium, 2000.
- 24 Casci J.L., Lowe B.M., Whittam T.V. (1981) Eur. Pat. 0 042 226.
- 25 Briscoe N.A., Johnson D.W., Shannon M.D., Kokotailo G.T., McCusker L.B. (1988) The framework topology of zeolite EU-1, *Zeolites* **8**, 74-76.
- 26 Souverijns W., Rombouts L., Martens J.A., Jacobs P.A. (1995) Molecular shape selectivity of EUO zeolites, *Micropor. Mat.* **4**, 123-130.
- 27 Moreau F. (2001) Isomérisation de l'éthylbenzène sur catalyseurs bifonctionnels zéolithiques. Rôle des fonctions acides et hydrogénantes, *PhD Thesis*, Université de Poitiers (LACCO).
- 28 Guisnet M. (2002) "Coke" molecules trapped in the micropores of zeolites as active species in hydrocarbon transformations, *J. Mol. Catal. A-Chem.* **182**, 1, 367-382.
- 29 Moreau F., Moreau P., Gnep N.S., Magnoux P., Lacombe S., Guisnet M. (2006) Ethylbenzene isomerization over bifunctional platinum alumina-EUO catalysts: Location of the active sites, *Micropor. Mesopor. Mat.* **90**, 1-3, 327-338.
- 30 Moreau P. (2005) *Isomérisation de l'Éthylbenzène sur catalyseurs bifonctionnels Pt/Zéolithe à taille de pores intermédiaire*, Université de Poitiers (LACCO).
- 31 Cerqueira H.S., Ayrault P., Datka J., Magnoux P., Guisnet M. (2000) m-Xylene Transformation over a USHY Zeolite at 523 and 723 K: Influence of Coke Deposits on Activity, Acidity, and Porosity, *J. Catal.* **196**, 1, 149-157.
- 32 Guisnet M., Magnoux P. (1989) Coking and deactivation of zeolites. Influence of the pore structure, *Appl. Catal.* **54**, 1-27.
- 33 Martens J.A., Vanbutsele G., Jacobs P.A., Denayer J., Ocakoglu R., Baron G., Arroyo J.A.M., Thybaut J., Marin G.B. (2001) Evidences for pore mouth and key-lock catalysis in hydroisomerization of long n-alkanes over 10-ring tubular pore bifunctional zeolites, *Catal. Today* **65**, 2-4, 111-116.
- 34 Claude M.C., Vanbutsele G., Martens J.A. (2001) Dimethyl branching of long n-alkanes in the range from decane to tetra-cosane on Pt/H-ZSM-22 bifunctional catalyst, *J. Catal.* **203**, 1, 213-231.
- 35 Guisnet M., Andy P., Boucheffa Y., Gnep N.S., Travers C., Benazzi E. (1998) Selective isomerization of n-butenes into isobutene over aged H-ferrierite catalyst: nature of the active species, *Catal. Lett.* **50**, 3-4, 159-164.
- 36 Andy P., Gnep N.S., Guisnet M., Benazzi E., Travers C. (1998) Skeletal isomerization of n-butenes - II. Composition, mode of formation, and influence of coke deposits on the reaction mechanism, *J. Catal.* **173**, 2, 322-332.
- 37 Moreau P., Gnep N.S., Magnoux P., Guillon E., Lacombe S., Guisnet M. (2008) Zeolites and Related Materials: Trends, Targets and Challenges, *Proceedings of the 4th International FEZA Conference*, Paris.
- 38 Rubin M.K. (1985) Eur. Pat. 0 159 845.
- 39 Sumitani K., Sakai T., Yamasaki Y., Onodera T. (1982) Eur. Pat. EP 51318.
- 40 Gault F.G. (1981) Skeletal isomerization of hydrocarbons, *Adv. Catal.* **30**, 28-48.
- 41 Brandenberger S.G., Callender W.L., Meerbott W.K. (1976) Mechanisms of Methylcyclopentane Ring opening over Pt-Alumina Catalysts, *J. Catal.* **42**, 282-287.
- 42 Donnis B.B. (1976) Platinum/alumina catalysts in reforming of methylcyclopentane, *Ind. Eng. Chem. Product Res. Dev.* **15**, 4, 254-258.
- 43 Smith R.L., Naro P.A., Silvestri A.J. (1971) Reactions Paths for Decyclization of Methylcyclopentane over Pt/Al₂O₃ Catalysts, *J. Catal.* **20**, 359-366.
- 44 Sozinho T. (2010) Étude mécanistique et cinétique des réactions de craquage dans des conditions de l'isomérisation de la coupe C₈ aromatique sur catalyseurs bifonctionnels, *PhD Thesis*, Université de Poitiers.

Final manuscript received in May 2009
Published online in September 2009

Copyright © 2009 Institut français du pétrole

Permission to make digital or hard copies of part or all of this work for personal or classroom use is granted without fee provided that copies are not made or distributed for profit or commercial advantage and that copies bear this notice and the full citation on the first page. Copyrights for components of this work owned by others than IFP must be honored. Abstracting with credit is permitted. To copy otherwise, to republish, to post on servers, or to redistribute to lists, requires prior specific permission and/or a fee: Request permission from Documentation, Institut français du pétrole, fax. +33 1 47 52 70 78, or revueogst@ifp.fr.